

Project: \_\_\_\_\_ Type: \_\_\_\_\_

Drawn by: \_\_\_\_\_ Catalogue #: \_\_\_\_\_ Date: \_\_\_\_\_

# LED REFLECTORS

## PAR38

5 CCT Selectable

### ORDERING INFORMATION

**Order code:** 69648  
**Model number:** P38/14W/5CCT/40/STD  
**UPC:** 069549028593  
**Case quantity:** 24

### PHYSICAL DATA

**Shape:** PAR38  
**Base:** E26  
**Heat sink color:** White

### PERFORMANCE DATA

**Watts (W):** 14  
**Volts (V AC):** 120  
**Color temperature (K):** 2 700/3 000/3 500/4 000/5 000  
**Lumen output (lm):** 1 200  
**Efficacy (lm/W):** 86  
**CRI:** 90  
**Life L70 (h):** 25 000  
**Dimming:** Phase-Cut (ELV / Triac)  
**Beam Angle (°):** 40  
**Power factor:** 0.97  
**Frequency (Hz):** 60  
**CBCP:** 2 500  
**Operating temp. range:** -30 °C to 45 °C (-22 °F to 113 °F)

<sup>1</sup> Typical colour temperature range: +/- 5 %.  
<sup>2</sup> Lumen values are derived from Energy Star reported data. Initial lumens range: +/- 10 %.  
<sup>3</sup> Life hours are derived from IESNA LM80-08 testing report and projected per IESNA TM-21-11 extrapolations.

### LUMEN SPECIFICATION TABLE

| 2 700 K           |                 | 3 000 K           |                 | 3 500 K           |                 | 4 000 K           |                 | 5 000 K           |                 |
|-------------------|-----------------|-------------------|-----------------|-------------------|-----------------|-------------------|-----------------|-------------------|-----------------|
| Lumen output (lm) | Efficacy (lm/W) | Lumen output (lm) | Efficacy (lm/W) | Lumen output (lm) | Efficacy (lm/W) | Lumen output (lm) | Efficacy (lm/W) | Lumen output (lm) | Efficacy (lm/W) |
| 1 243             | 89              | 1 330             | 95              | 1 401             | 100             | 1 404             | 100             | 1 307             | 93              |

#### DEFAULT PROGRAMMING

2 700 K

### COMPATIBLE DIMMERS<sup>1</sup>

| Brand   | Model  |
|---------|--|
| LUTRON  | CTCL-153P, DVCL-253P, DVELV-300P, HCL453P, MACL-153P, PD-6WCL, SELV-300P |
| COOPER  | AAL06, DAL06P  |
| LEVITON | 6674, DDMX1, DSL06-1LZ, IPL06, DSM10-1LZ, IPE04-1LZ                      |
| LEGRAND | RH730PTUTC   |

<sup>1</sup> This table shows dimmers that have been tested and have demonstrated proper operation under normal conditions. Each installation being unique, various factors such as load, common neutrals or other electrical products on the circuit can, in certain instances, cause variance in system performance. Read and comply to the dimmer installation instructions. Consult dimming system manufacturer for additional support in operation. Some dimmers may require more than one product for stable operation. Standard recommends to use dimmers designed to work with LED products. Older dimmers designed for incandescent products may cause erratic operation.

### DIMENSIONS

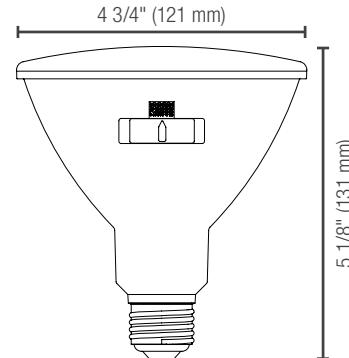

ICES 005



enclosed fixture

